

G8PE

PCB relay for automobile use (high wattage)

High current carrying and switching automotive PCB relay.

- Capable of continuous energization at 40A.



■ Purpose

- Blower fan, defogger, headlight

■ Type standard

G8PE¹-□²□³□⁴

	Classification	Symbol	Meaning of the symbol
1	Basic type	G8PE	high power relay for automobile use
2	Number of contact poles	1	Number of contact poles
3	Contact configuration	A	1a (SPST)
		C	1c (SPDT)
4	Protective construction	4	Simple plastic seal

■ Ratings/Performance

Type		G8PE-1A4	G8PE-1C4
Item		Standard	
Coil	Rated coil voltage	12 VDC	
	Coil resistance (at 20°C)	135Ω ±10%	
	Service voltage range	10 to 16 VDC	
	Operating voltage (at 20°C)	6.8 V or less	
	Release voltage (at 20°C)	1.0 V or more	
Contact	Contact configuration	1a(SPST)	1c(SPDT)
	Contact material	AgSn type (non-cadmium)	
	Rated load	12 VDC 40 A (at 20°C) 12 VDC 30 A (at 105°C)	
	Max switching current	Inrush: 180 A(NO)/60 A(NC)	
	Continues switching current	40 A (NO)/25 A (NC)	
Endurance (Lifetime)	Mechanical	1,000,000 times	
	Electrical (Rated load)	100,000 times	
Mechanical	Impact resistance	Malfunction	100 m/s ²
		Destruction	1,000 m/s ²
	Vibration resistance	Malfunction	5~400 Hz 44.1 m/s ²
		Destruction	5~100 Hz 44.1 m/s ²
Ambient temperature range		-30~+105°C	
Weight		About 20 g	

■ Reference Data

• Operating voltage/Release voltage

Sample: G8PE-1C4 12 VDC 135 Ω 30 pcs

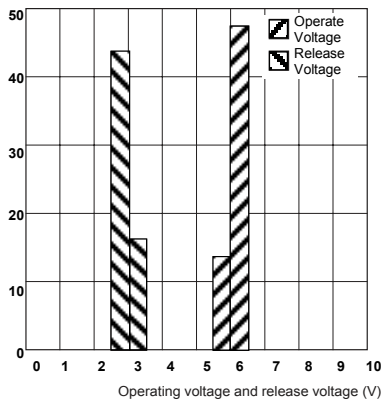

• Operating time/Release time

Sample: G8PE-1C4 12 VDC 135 Ω 30 pcs

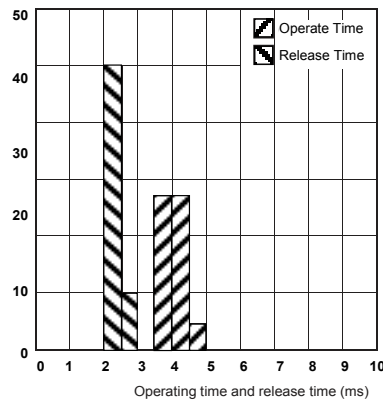

• Contact resistance

Sample: G8PE-1C4 12 VDC 135 Ω 30 pcs

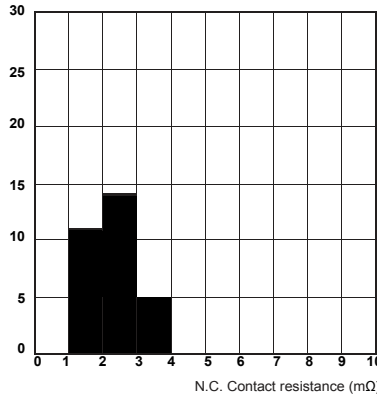
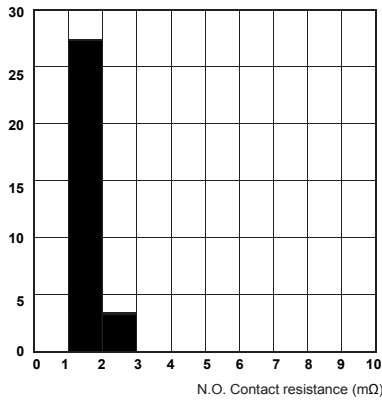

• Coil temperature rise

Sample: G8PE-1C4 12 VDC 135 Ω 30 pcs

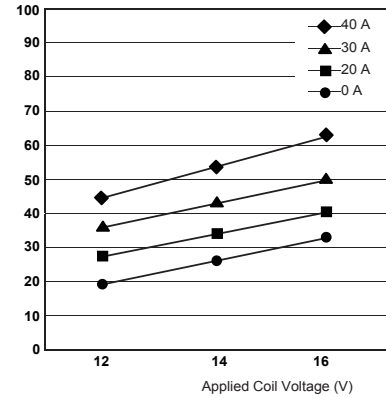

• Ambient temperature and service voltage range (Cold start)

G8PE-1C4

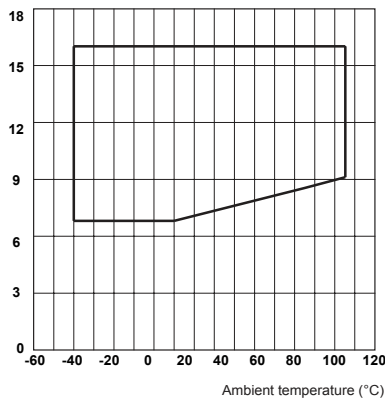

■ Electrical endurance (Lifetime)

Spec	Application/Load	Load current	Switching frequency	Switching time
G8PE-1A4	240 W head lamp	Input 100 A steady 20 A	On1 s/Off6 s	200,000
G8PE-1C4	Motor lock	Motor lock current 40 A	On0.7 s/Off7.0 s	105,000
G8PE-1C4	Resistance	Steady 40 A	On2 s/Off3 s	200,000

■ Dimensions (unit: mm)

G8PE-1C4

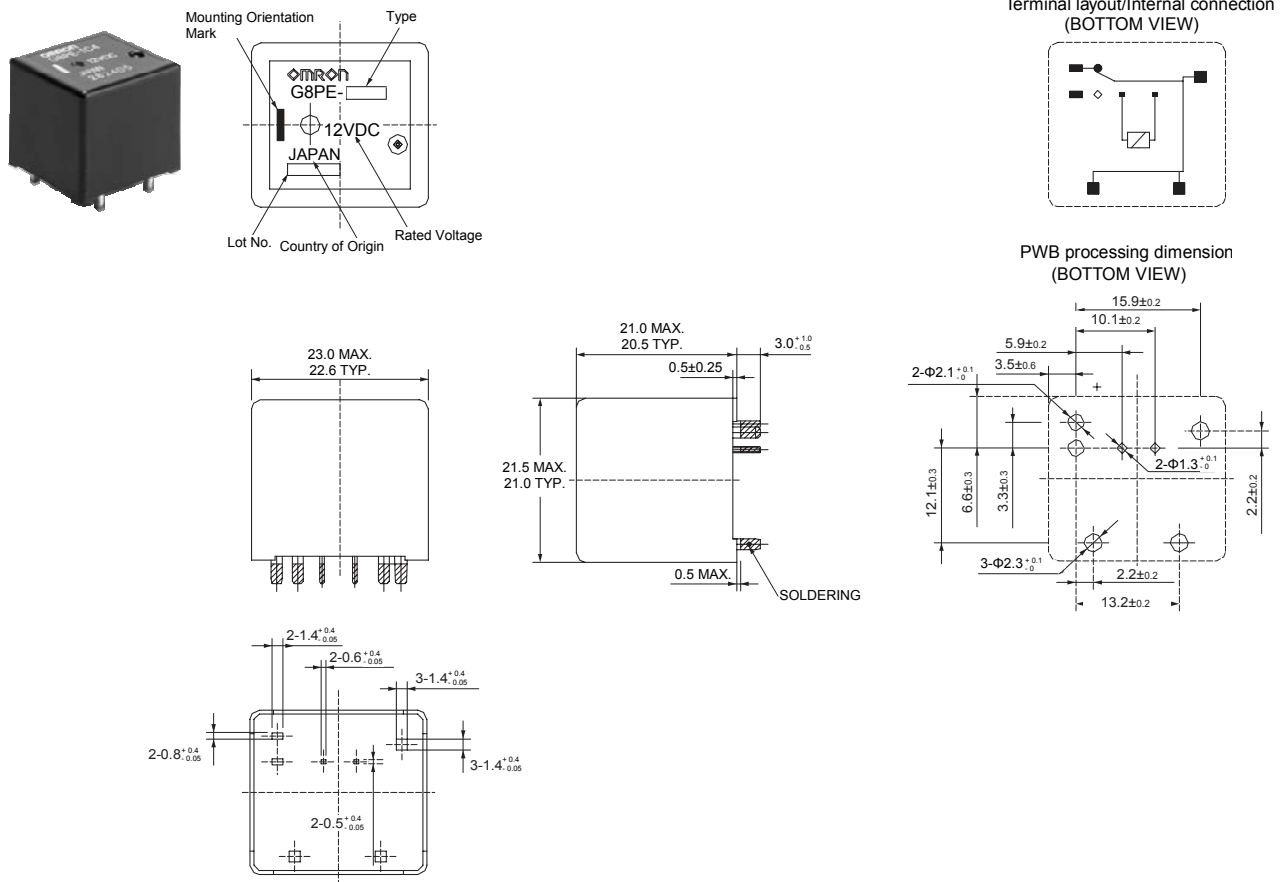

* Tolerance unless otherwise specified

Less than 1 mm:	±0.1 mm
Less than 1~3 mm:	±0.2 mm
3 mm or more:	±0.3 mm